



IGBT Modules

V _{CES}	1200V
I _C	50A

Applications

- Motor Drivers
- AC and DC servo drive amplifier
- UPS (Uninterruptible Power Supplies)

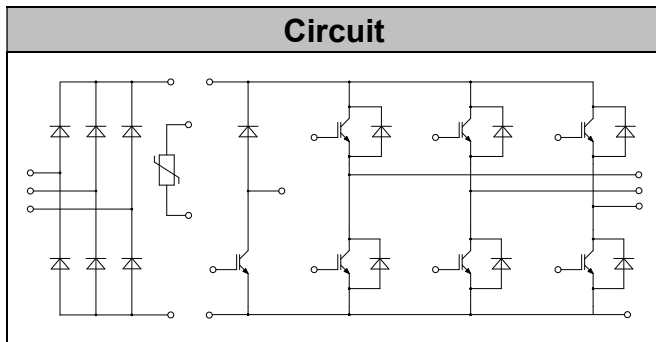

Features

- Low switching losses
- Low V_{ce(sat)} with positive temperature coefficient
- Including fast & soft recovery anti-parallel FWD
- Low inductance case
- High short circuit capability(10us)
- Maximum junction temperature 175°C

● IGBT- inverter

Absolute Maximum Ratings

Parameter	Symbol	Conditions	Value	Unit
Collector-Emitter Voltage	V _{CES}	V _{GE} =0V, I _C =1mA, T _{vj} =25°C	1200	V
Continuous Collector Current	I _C	T _c =100°C, T _{vjmax} =175°C	50	A
Repetitive Peak Collector Current	I _{CRM}	t _p =1ms	100	A
Gate-Emitter Voltage	V _{GES}	T _{vj} =25°C	± 20	V
Total Power Dissipation	P _{tot}	T _c =25°C T _{vjmax} =175°C	288	W



● IGBT- inverter

Characteristic values

Parameter	Symbol	Conditions	Value			Unit
			Min.	Typ.	Max.	
Gate-emitter Threshold Voltage	$V_{GE(th)}$	$V_{GE}=V_{CE}, I_C=1.7mA, T_{vj}=25^{\circ}C$	5.2	5.8	6.4	V
Collector-Emitter Cut-off Current	I_{CES}	$V_{CE}=1200V, V_{GE}=0V, T_{vj}=25^{\circ}C$			1.0	mA
Collector-Emitter Saturation Voltage	$V_{CE(sat)}$	$I_C=50A, V_{GE}=15V, T_{vj}=25^{\circ}C$		1.90	2.30	V
		$I_C=50A, V_{GE}=15V, T_{vj}=125^{\circ}C$		2.20		
		$I_C=50A, V_{GE}=15V, T_{vj}=150^{\circ}C$		2.30		
Gate Charge	Q_G			0.35		uC
Input Capacitance	C_{ies}	$V_{CE}=25V, V_{GE}=0V,$ $f=1MHz, T_{vj}=25^{\circ}C$		2.60		nF
Reverse Transfer Capacitance	C_{res}			0.10		nF
Gate-Emitter leakage current	I_{GES}	$V_{CE}=0V, V_{GE}=20V, T_{vj}=25^{\circ}C$			400	nA
Turn-on Delay Time	$t_{d(on)}$	$I_C=50A$ $V_{CE}=600V$ $V_{GE}=\pm 15V$ $R_G=15\Omega$ $T_{vj}=25^{\circ}C$		168		ns
Rise Time	t_r			34		ns
Turn-off Delay Time	$t_{d(off)}$			320		ns
Fall Time	t_f			78		ns
Energy Dissipation During Turn-on Time	E_{on}			5.42		mJ
Energy Dissipation During Turn-off Time	E_{off}			4.15		mJ
Turn-on Delay Time	$t_{d(on)}$	$I_C=50A$ $V_{CE}=600V$ $V_{GE}=\pm 15V$ $R_G=15\Omega$ $T_{vj}=125^{\circ}C$		175		ns
Rise Time	t_r			42		ns
Turn-off Delay Time	$t_{d(off)}$			426		ns
Fall Time	t_f			148		ns
Energy Dissipation During Turn-on Time	E_{on}			7.26		mJ
Energy Dissipation During Turn-off Time	E_{off}			5.80		mJ
SC Data	I_{sc}	$T_p \leq 10\mu s, V_{GE}=15V, T_{vj}=150^{\circ}C,$ $V_{cc}=900V, V_{CEM} \leq 1200V$		220		A



● Diode-inverter

Absolute Maximum Ratings

Parameter	Symbol	Conditions	Value	Unit
Repetitive Peak Reverse Voltage	V_{RRM}	$T_{vj}=25^{\circ}C$	1200	V
Continuous DC Forward Current	I_F		50	A
Repetitive Peak Forward Current	I_{FRM}	$t_p=1ms$	100	A
I^2t -value	I^2t	$V_R=0, t_p=10ms, T_{vj}=125^{\circ}C$	560	A ² s
		$V_R=0, t_p=10ms, T_{vj}=150^{\circ}C$	480	

Characteristic values

Parameter	Symbol	Conditions	Value			Unit
			Min.	Typ.	Max.	
Forward Voltage	V_F	$I_F=50A, T_{vj}=25^{\circ}C$		2.10	2.50	V
		$I_F=50A, T_{vj}=125^{\circ}C$		2.15		
		$I_F=50A, T_{vj}=150^{\circ}C$		2.15		
Recovered Charge	Q_{rr}	$I_F=50A$		5.8		μC
Peak Reverse Recovery Current	I_{rr}	$V_R=600V$ $-di_F/dt=1500A/\mu s$		56		A
Reverse Recovery Energy	E_{rec}	$T_{vj}=25^{\circ}C$		1.85		mJ
Recovered Charge	Q_{rr}	$I_F=50A$		9.1		μC
Peak Reverse Recovery Current	I_{rr}	$V_R=600V$ $-di_F/dt=1500A/\mu s$		58		A
Reverse Recovery Energy	E_{rec}	$T_{vj}=125^{\circ}C$		3.30		mJ



● IGBT-brake-chopper Absolute Maximum Ratings

Parameter	Symbol	Conditions	Value	Unit
Collector-Emitter Voltage	V_{CES}	$V_{GE}=0V, I_C=1mA, T_{vj}=25^{\circ}C$	1200	V
Continuous Collector Current	I_C	$T_c=100^{\circ}C, T_{vjmax}=175^{\circ}C$	35	A
Repetitive Peak Collector Current	I_{CRM}	$t_p=1ms$	70	A
Gate-Emitter Voltage	V_{GES}	$T_{vj}=25^{\circ}C$	± 20	V
Total Power Dissipation	P_{tot}	$T_c=25^{\circ}C$ $T_{vjmax}=175^{\circ}C$	227	W

Characteristic values

Parameter	Symbol	Conditions	Value			Unit
			Min.	Typ.	Max.	
Gate-emitter Threshold Voltage	$V_{GE(th)}$	$V_{GE}=V_{CE}, I_C=1.4mA, T_{vj}=25^{\circ}C$	5.2	5.8	6.4	V
Collector-Emitter Cut-off Current	I_{CES}	$V_{CE}=1200V, V_{GE}=0V, T_{vj}=25^{\circ}C$			1.0	mA
Collector-Emitter Saturation Voltage	$V_{CE(sat)}$	$I_C=35A, V_{GE}=15V, T_{vj}=25^{\circ}C$		1.85	2.25	V
		$I_C=35A, V_{GE}=15V, T_{vj}=125^{\circ}C$		2.15		
		$I_C=35A, V_{GE}=15V, T_{vj}=150^{\circ}C$		2.25		
Gate Charge	Q_G			0.27		uC
Input Capacitance	C_{ies}	$V_{CE}=25V, V_{GE}=0V,$ $f=1MHz, T_{vj}=25^{\circ}C$		2.00		nF
Reverse Transfer Capacitance	C_{res}			0.07		nF
Gate-Emitter leakage current	I_{GES}	$V_{CE}=0V, V_{GE}=20V, T_{vj}=25^{\circ}C$			400	nA
Turn-on Delay Time	$t_{d(on)}$	$I_C=35A$ $V_{CE}=600V$ $V_{GE}=\pm 15V$ $R_G=12\Omega$ $T_{vj}=25^{\circ}C$		25		ns
Rise Time	t_r			13		ns
Turn-off Delay Time	$t_{d(off)}$			24		ns
Fall Time	t_f			115		ns
Energy Dissipation During Turn-on Time	E_{on}			1.90		mJ
Energy Dissipation During Turn-off Time	E_{off}			2.00		mJ



Turn-on Delay Time	$t_{d(on)}$	$I_C = 35\text{ A}$ $V_{CE} = 600\text{ V}$ $V_{GE} = \pm 15\text{ V}$ $R_G = 12\Omega$ $T_{vj} = 125^\circ\text{C}$	25	ns
Rise Time	t_r		16	ns
Turn-off Delay Time	$t_{d(off)}$		295	ns
Fall Time	t_f		170	ns
Energy Dissipation During Turn-on Time	E_{on}		2.90	mJ
Energy Dissipation During Turn-off Time	E_{off}		2.90	mJ
SC Data	I_{sc}		$T_p \leq 10\mu\text{s}, V_{GE} = 15\text{ V}, T_{vj} = 150^\circ\text{C},$ $V_{cc} = 900\text{ V}, V_{CEM} \leq 1200\text{ V}$	150

● Diode-Brake-Chopper

Absolute Maximum Ratings

Parameter	Symbol	Conditions	Value	Unit
Repetitive Peak Reverse Voltage	V_{RRM}	$T_j = 25^\circ\text{C}$	1200	V
Continuous DC Forward Current	I_F		15	A
Repetitive Peak Forward Current	I_{FRM}	$t_p = 1\text{ ms}$	30	A
I^2t -value	I^2t	$V_R = 0, t_p = 10\text{ ms}, T_j = 125^\circ\text{C}$	16.0	A ² s
		$V_R = 0, t_p = 10\text{ ms}, T_j = 150^\circ\text{C}$	14.0	

Characteristic values

Parameter	Symbol	Conditions	Value			Unit
			Min.	Typ.	Max.	
Forward Voltage	V_F	$I_F = 15\text{ A}, T_{vj} = 25^\circ\text{C}$		2.00		V
		$I_F = 15\text{ A}, T_{vj} = 125^\circ\text{C}$		2.10		
		$I_F = 15\text{ A}, T_{vj} = 150^\circ\text{C}$		2.10		
Recovered Charge	Q_{rr}	$I_F = 15\text{ A}$		1.10		μC
Peak Reverse Recovery Current	I_{rr}	$V_R = 600\text{ V}$ $-di_F/dt = 550\text{ A}/\mu\text{s}$		12.0		A
Reverse Recovery Energy	E_{rec}	$T_{vj} = 25^\circ\text{C}$		0.30		mJ
Recovered Charge	Q_{rr}	$I_F = 15\text{ A}$		1.90		μC
Peak Reverse Recovery Current	I_{rr}	$V_R = 600\text{ V}$ $-di_F/dt = 550\text{ A}/\mu\text{s}$		14.0		A
Reverse Recovery Energy	E_{rec}	$T_{vj} = 125^\circ\text{C}$		0.60		mJ



● Diode-Rectifier

Absolute Maximum Ratings

Parameter	Symbol	Conditions	Value	Unit
Repetitive Peak Reverse Voltage	V_{RRM}	$T_j=25^{\circ}\text{C}$	1600	V
Average output Current 50/60Hz, sine wave	$I_{F(AV)}$	$T_c=100^{\circ}\text{C}$	65	A
Maximum RMS Current at Rectifier Output	I_{RMSM}	$T_c=100^{\circ}\text{C}$	110	A
Surge Forward Current	I_{FSM}	$V_R=0, t_p=10\text{ms}, T_j=45^{\circ}\text{C}$	850	A
I^2t -value	I^2t	$V_R=0, t_p=10\text{ms}, T_j=45^{\circ}\text{C}$	3610	A^2s

Characteristic values

Parameter	Symbol	Conditions	Value			Unit
			Min.	Typ.	Max.	
Diode Forward Voltage	V_F	$I_F=50\text{A}, T_j=125^{\circ}\text{C}$		1.0		V
Reverse Current	I_R	$T_j=125^{\circ}\text{C}, V_R=1600\text{V}$			1.5	mA

● NTC-Thermistor

Characteristic values

Parameter	Symbol	Conditions	Value			Unit
			Min.	Typ.	Max.	
Rated Resistance	R_{25}			5.0		$\text{k}\Omega$
Deviation of R100	$\Delta R/R$	$T_c=100, R_{100}=493.3\Omega$	-5		5	%
Power Dissipation	P_{25}				20.0	mW
B-value	$B_{25/50}$	$R_2=R_{25}\exp[B_{25/50}(1/T_2-1/(298.15\text{K}))]$		3375		K

**● Module Characteristics** $T_C=25^{\circ}\text{C}$ unless otherwise specified

Parameter	Symbol	Conditions	Value			Unit
			Min.	Typ.	Max.	
Isolation voltage	V_{isol}	$t=1\text{min}, f=50\text{Hz}$	2500			V
Maximum Junction Temperature	T_{jmax}				175	$^{\circ}\text{C}$
Operating Junction Temperature	$T_{\text{vj op}}$		-40		150	$^{\circ}\text{C}$
Storage Temperature	T_{stg}		-40		125	$^{\circ}\text{C}$
Stray-inductance-module	L_{SCE}			60		nH
Module lead resistance, terminals-chip	$R_{\text{CC'+EE'}}$	$T_C=25^{\circ}\text{C}$, per switch		4.0		m Ω
	$R_{\text{AA'+CC'}}$			3.0		
Thermal Resistance Junction-to Case	$R_{\theta \text{ JC}}$	per IGBT-inverter			0.52	K/W
		per Diode-inverter			0.81	
		per IGBT-brake-copper			0.66	
		per Diode-chopper			1.50	
		per Diode-rectifier			0.64	
Thermal Resistance Case-to Sink	$R_{\theta \text{ CS}}$	per IGBT-inverter		0.29		K/W
		per Diode-inverter		0.44		
		per IGBT-brake-copper		0.32		
		per Diode-chopper		0.33		
		per Diode-rectifier		0.70		
		per Module		0.009		
Mounting Force Per Clamp	F		3.0		6.0	N
Weight of Module	G			300		g

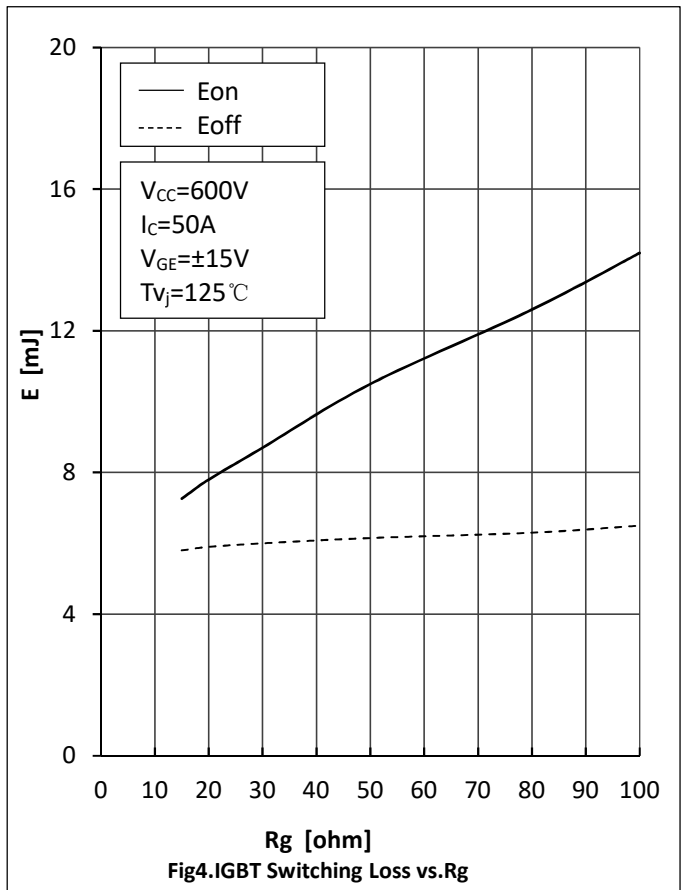
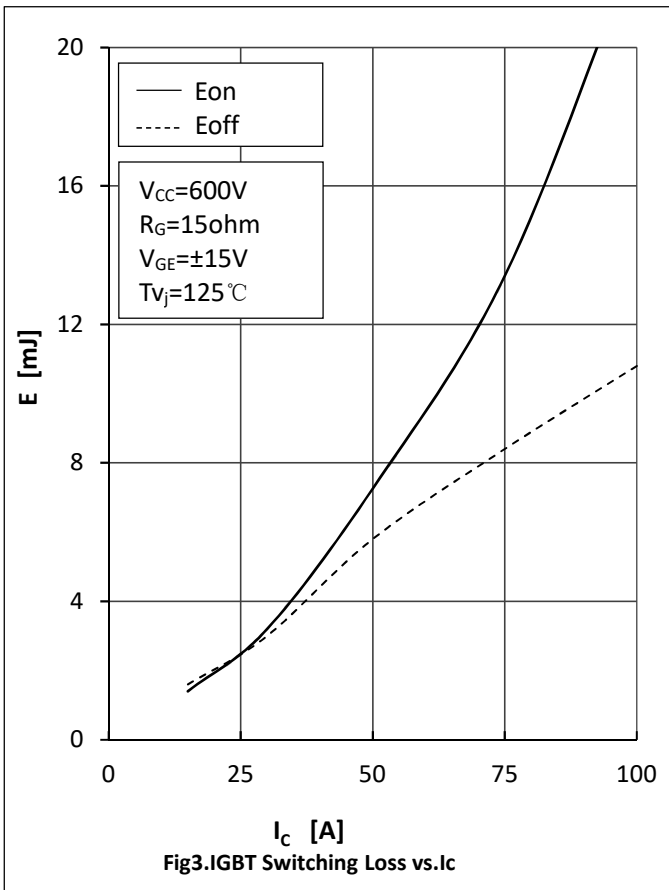
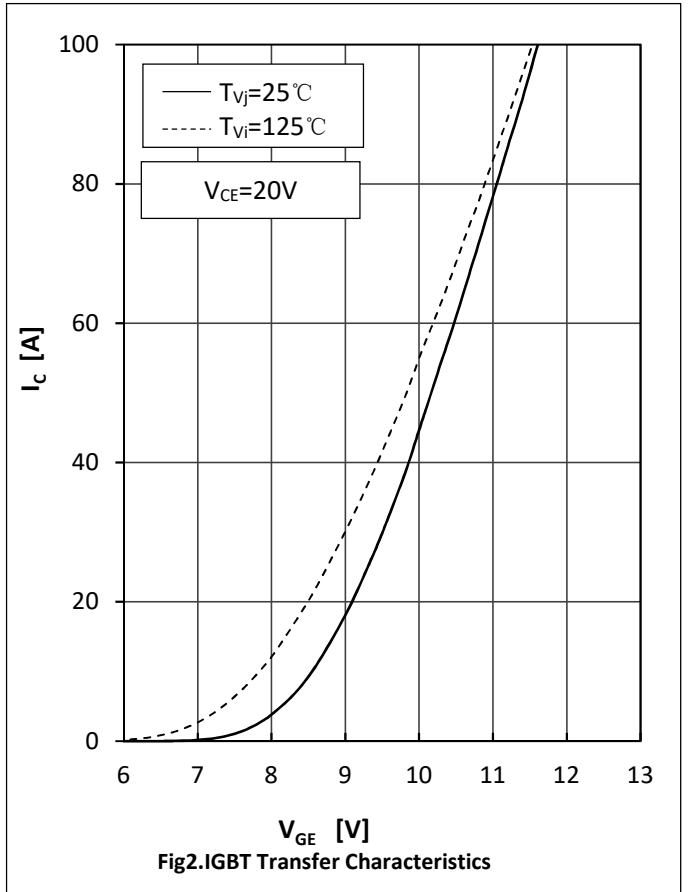
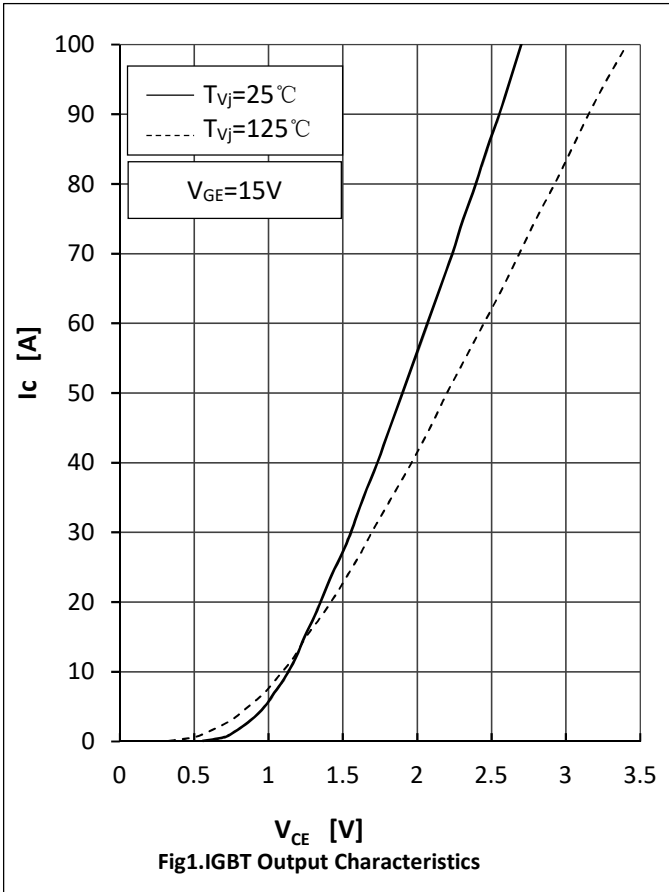

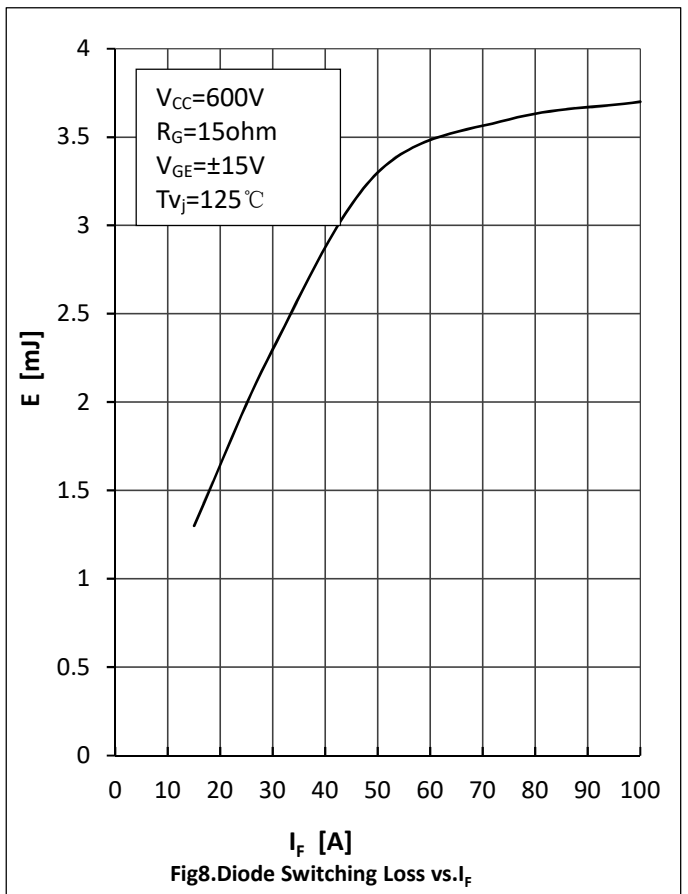
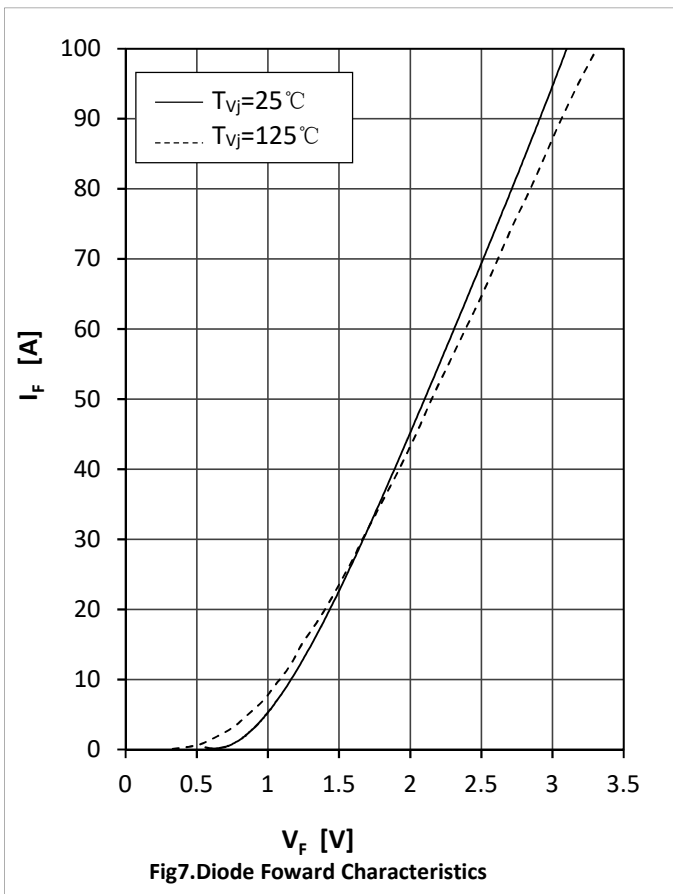
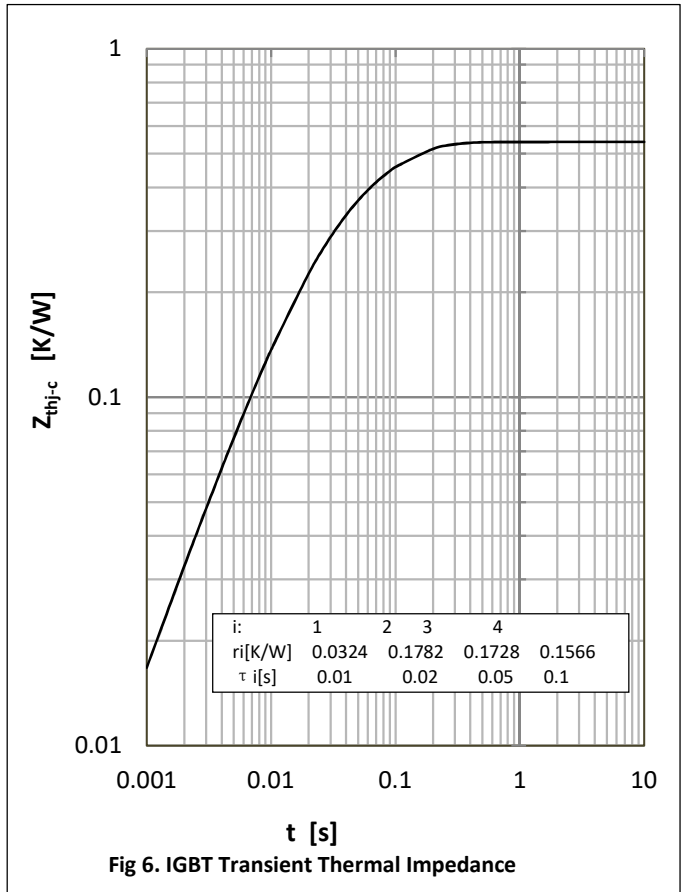
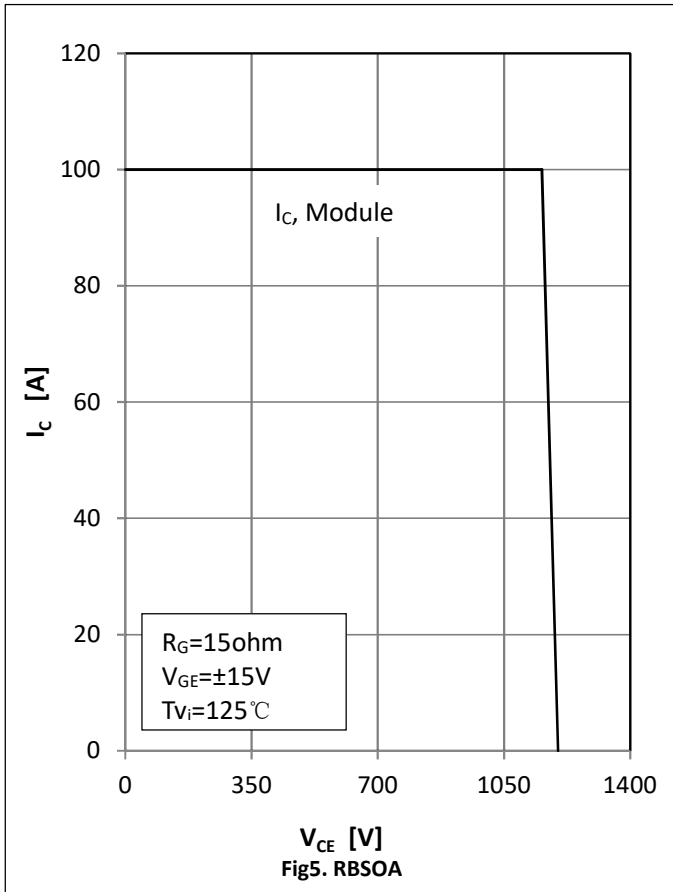

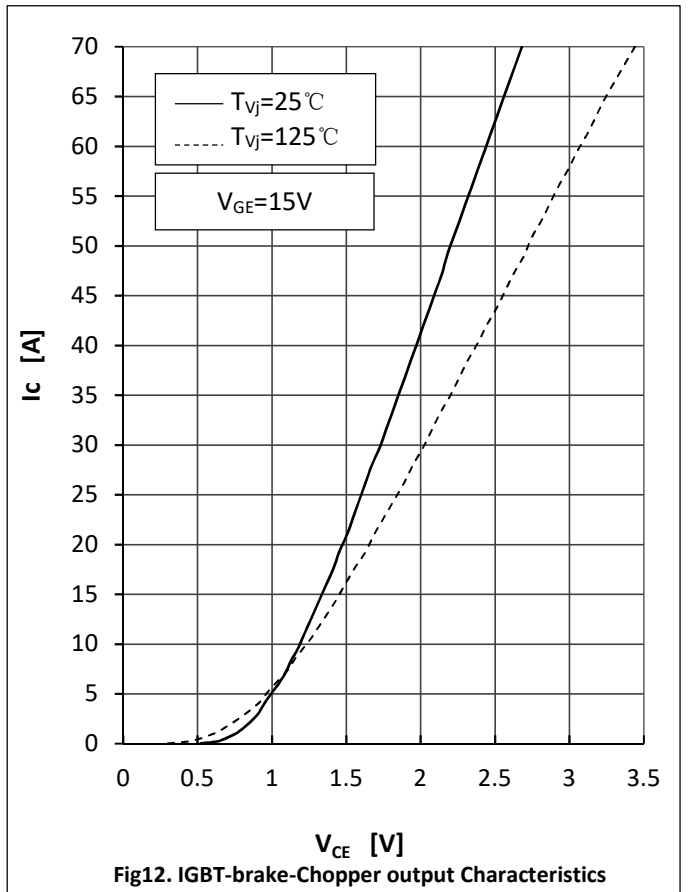
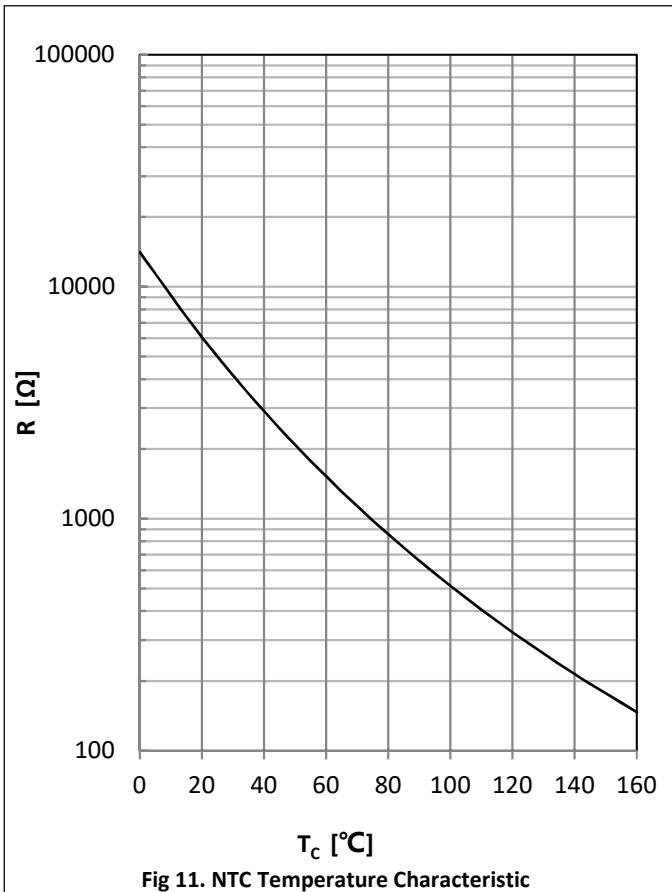
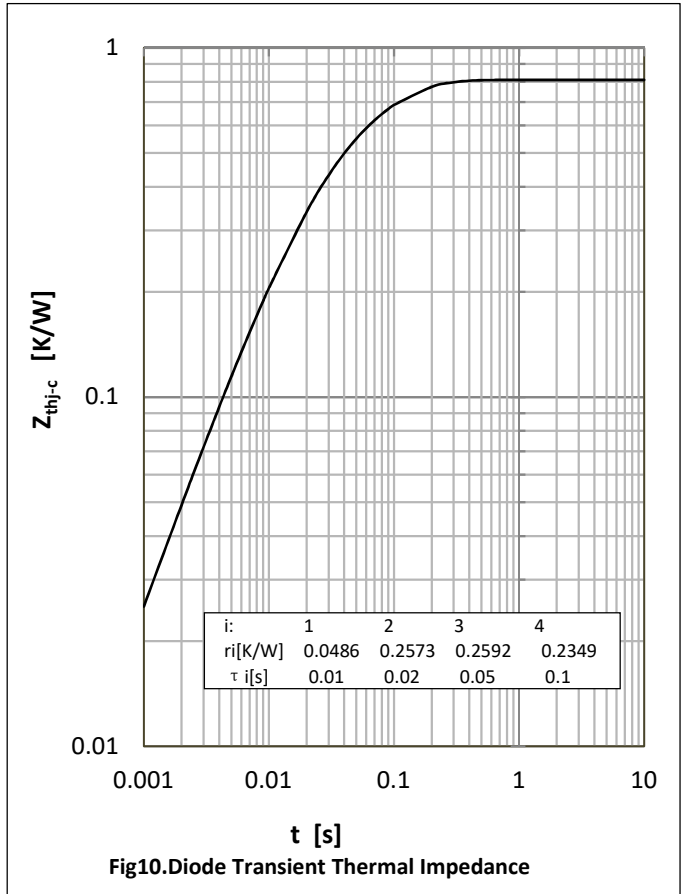
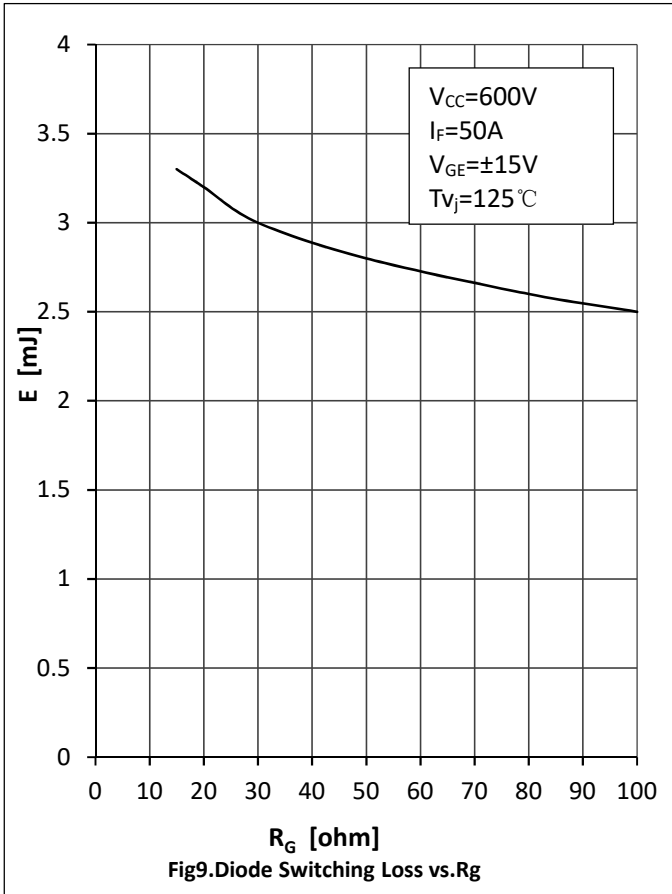

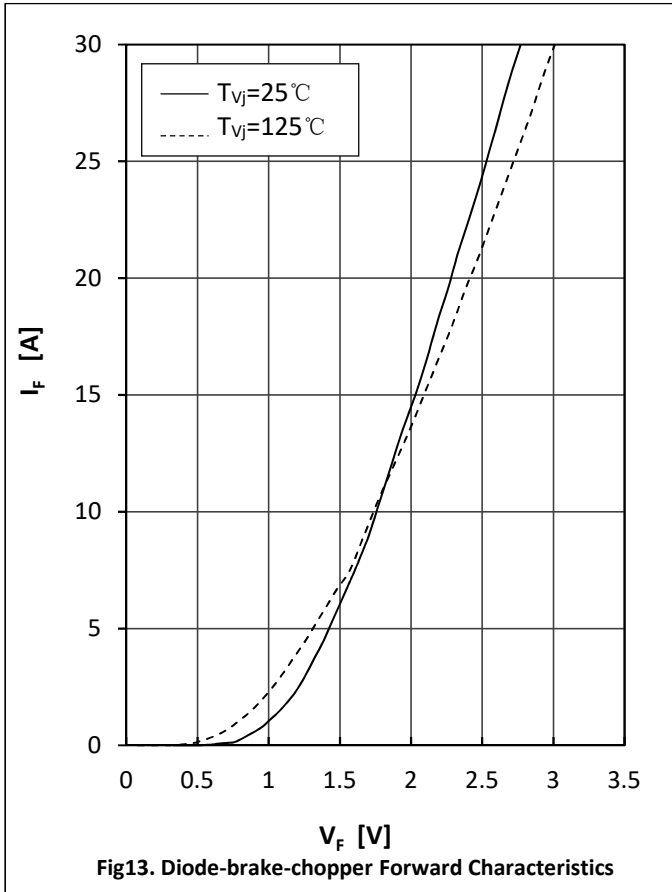



● Circuit Diagram

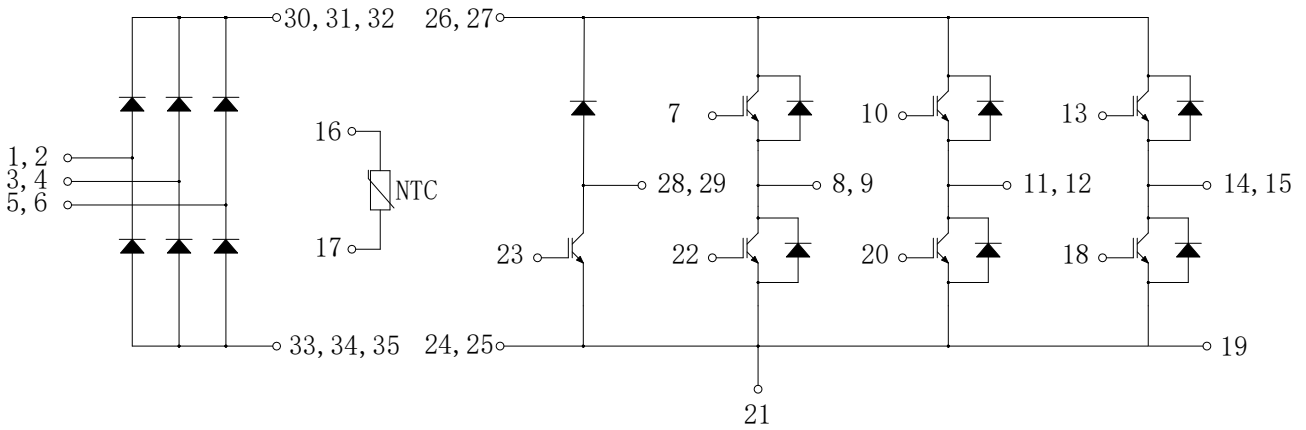

● Package Outline Information

